

High-Speed Counter I/O Module



Overview

The High-Speed Counter I/O (CTRIO) module is designed to accept high-speed pulse-type input signals for counting or timing applications and to provide high-speed pulse-type output signals for stepper motor control, monitoring, alarm or other discrete control functions. The CTRIO module offers great flexibility for applications that call for precise counting or timing, based on an input event or for high-speed control output applications.

The CTRIO module has its own micro-processor and operates asynchronously with respect to the PLC/controller. This means that the on-board outputs respond in real time to incoming signals, so there is no delay waiting for the PLC/Controller to scan I/O.

The H2-CTRIO module is designed to work with incremental encoders or other field devices that send pulse outputs.

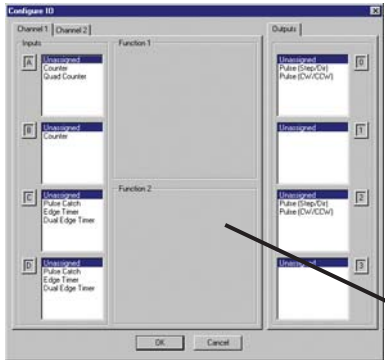

CTRIO features

The CTRIO modules offer the following I/O features:

- Eight DC sink/source inputs, 9-30 VDC
- Four isolated sink/source DC outputs, 5-30 VDC, 1A per point

Inputs supported:

- Two quadrature encoder counters up to 100 kHz, or four single-channel counters up to 100 kHz using module terminals Ch1A, Ch1B, Ch2A and Ch2B
- High-speed edge timers, dual edge timers, pulse catch, count reset, count inhibit, or count capture or home search limits using module terminals Ch1C, Ch1D, Ch2C or Ch2D

Outputs supported:

- Four independently configurable high-speed discrete outputs or two channels pulse output control (20 Hz-25 kHz per channel or 50 kHz if only using one channel)
- Pulse and direction or cw/ccw pulses supported for pulse output control
- Raw control of discrete output directly from user control program

Software configuration

All scaling and configuration is done via CTRIO Workbench, a Windows software utility program. This eliminates the need for PLC ladder programming or other interface device programming to set up the module. CTRIO Workbench runs under Windows 98/2000/XP and NT 4.0 SP5 or later.

CTRIO Workbench main configuration screen

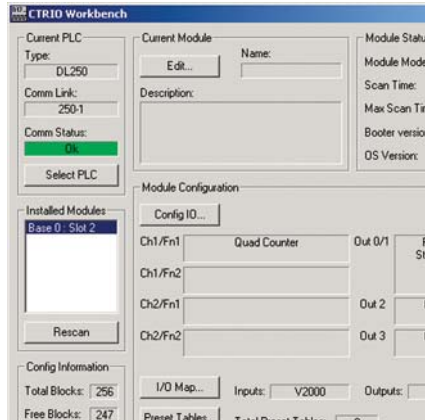

Use Configure I/O dialog to assign the CTRIO input and output functions

Typical applications

- High-speed cut-to-length operations using encoder input
- Pick-and-place or indexing functions controlling a stepper drive
- Dynamic registration for web material control
- Accurate frequency counting for speed control with onboard scaling
- PLS (Programmable Limit Switch) functions for high-speed packaging, gluing, or labeling
- Sub 10 μsec pulse-catch capability for high-speed product detection
- Functions for level or flow

Supported systems

Multiple T1H-CTRIO modules can reside in the same I/O system provided that the base power budget is adequate.

PC-based Ethernet I/O control systems

The T1H-CTRIO module can be used in PC-based control systems using the T1H-EBC(100) interface module.

Profibus systems

The T1H-CTRIO module can be used in Profibus systems using the T1H-PBC slave interface module.

ERM to EBC systems

The T1H-CTRIO module is supported in T1H-EBC(100) slaves in H*-ERM systems.

Notes:

1. The T1H-CTRIO module is not supported in T1K-RSSS serial remote I/O bases.
2. System functions are not available when CTRIO is used in ERM/EBC expansion I/O.

- PLC Overview
- DL05/06 PLC
- DL105 PLC
- DL205 PLC
- DL305 PLC
- DL405 PLC
- Field I/O**
- Software
- C-more HMI's
- Other HMI
- AC Drives
- Motors
- Steppers/Servos
- Motor Controls
- Proximity Sensors
- Photo Sensors
- Limit Switches
- Encoders
- Pushbuttons/Lights
- Process
- Relays/Timers
- Comm.
- TB's & Wiring
- Power
- Enclosures
- Appendix
- Part Index

High-Speed Counter

I/O Specifications

General	
Module Type	Intelligent
Modules Per Base	Limited only by power consumption
I/O Points Used	None, I/O map directly in PLC V-memory or PC control access
Field Wiring Connector	Standard removable terminal block
Internal Power Consumption	400 mA Max at +5V from Base Power Supply, Maximum of 6 Watts (All I/O in ON State at Max Voltage/Current)
Operating Environment	32°F to 140°F (0°C to 60°C), Humidity (non-condensing) 5% to 95%
Manufacturer	Host Automation Products, LLC
Isolation	2500 V I/O to Logic, 1000 V among Input Channels and All Outputs

T1H-CTRIO Input Specifications	
Inputs	8 pts sink/source
Minimum Pulse Width	5 µsec
Input Voltage Range	9-30 VDC
Maximum Voltage	30 VDC
Input Voltage Protection	Zener Clamped at 33 VDC
Rated Input Current	8 mA typical 12 mA maximum
Minimum ON Voltage	9.0 VDC
Maximum OFF Voltage	2.0 VDC
Minimum ON Current	5.0 mA (9 VDC required to guarantee ON state)
Maximum OFF Current	2.0 mA
OFF to ON Response	Less than 3 µsec
ON to OFF Response	Less than 3 µsec

T1H-CTRIO Output Specifications	
Outputs	4 pts, independently isolated, current sourcing or sinking FET Outputs: open drain and source with floating gate drive
Voltage Range	5 VDC - 36 VDC
Maximum Voltage	36 VDC
Output Clamp Voltage	60 VDC
Maximum Load Current	1.0 A
Maximum Load Voltage	36 VDC
Maximum Leakage Current	100 µA
Inrush Current	5 A for 20 ms
OFF to ON Response	Less than 3 µsec
ON to OFF Response	Less than 3 µsec
ON State V Drop	≤ 0.3 V
External Power Supply	For loop power only, not required for internal module function*
Overcurrent Protection	15 A max
Thermal Shutdown	Tjunction = 150°C
Overtemperature Reset	Tjunction = 130°C
Duty Cycle Range	1% to 99% in 1% increments (default = 50%)
Configurable Presets	a) Each output can be assigned one preset, or b) Each output can be assigned one table of presets, one table can contain max. 128 presets, max. predefined tables = 255
a) single	
b) multiple	

* User supplied power source required for stepper drive configuration.

T1H-CTRIO Input Resources	
Counter/Timer	4, (2 per 4 input channel group) up to 100 kHz
Resource Options	1X, 2X, or 4X Quadrature, Up or Down Counter, Edge Timer, Dual Edge Timer, Input Pulse Catch, Reset, Inhibit, Capture
Timer Range / Resolution	4.2 billion (32 bits); 1 µsec
Counter Range	± 2.1 billion (31 bits + sign bit)

T1H-CTRIO Output Resources	
Pulse output / Discrete outputs	Pulse outputs: 2 channels (2 outputs each channel) Discrete outputs: 4 pts.
Resource Options	Pulse outputs: pulse/direction or cw/ccw; Profiles: Trapezoid, S-Curve, Symmetrical S-Curve, Dynamic Position, Dynamic Velocity, Home Search, Velocity Mode, Run to Limit Mode and Run to Position Mode Discrete outputs: 4 configurable for set, reset, pulse on, pulse off, toggle, reset count functions (assigned to respond to Timer/Counter input functions). Raw mode: Direct access to discrete output from user application program
Target Position Range	± 2.1 billion (32 bits or 31 bits + sign bit)

High-Speed Counter

Status indicators

T1H-CTRIO LED Descriptions	
OK	Module OK
ER	User Program Error
1A - 1D	Ch1A - Ch1D Input Status
2A - 2D	Ch2A - Ch2D Input Status
CH1	Channel 1 Status
CH2	Channel 2 Status
Y0 - Y3	Output Status

T1H-CTRIO- LED Diagnostic Definitions		
LED OK	LED ER	Description
ON	OFF	All is well - RUN Mode
ON	ON	Hardware Failure
Blinking	Blinking	Boot Mode - Used for Field OS Upgrades
Blinking	OFF	Program Mode
OFF	Blinking	Module Self-diagnostic Failure
OFF	ON	Module Error Due to Watchdog Timeout
OFF	OFF	No Power to Module

T1H-CTRIO LED Diagnostic Definition	
CH1	Blinks when Channel 1 Function 1 is counting or timing
CH2	Blinks when Channel 2 Function 1 is counting or timing
Y0 - Y3	Follow actual output state; ON = output is passing current

Installation and wiring

The T1H-CTRIO module has two independent input channels, each consisting of four optically isolated input points (points 1A-1D on common 1M and points 2A-2D on common 2M). The inputs can be wired to either sink or source current. The module has four optically isolated output points (points Y0-Y3 on isolated commons C0-C3, respectively). The outputs must be wired so that positive current flows into the Cn terminal and then out of the Yn terminal (see the diagram below and the schematic on the following page).

The module is configured, using CTRIO Workbench, to accommodate the user's application. The function of each input (counting, timing, reset, etc.) and output (pulse output, discrete output, etc.) is defined in the configuration of the module.

See the notes below for further details about power source considerations, circuit polarities, and field devices.

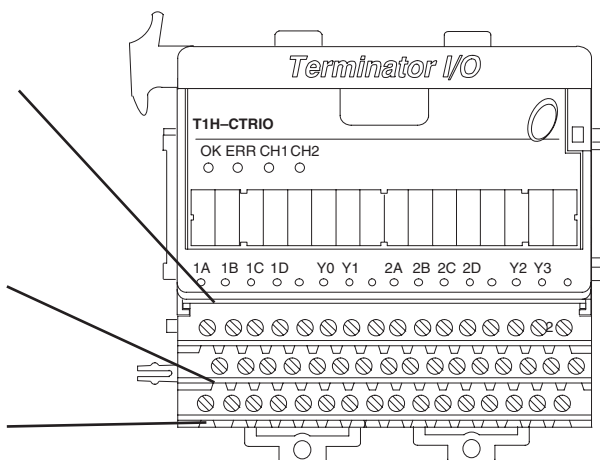
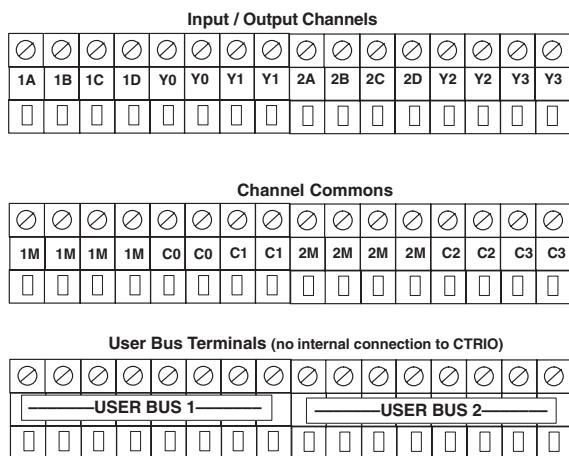

Notes:

- Inputs (1A, 1B, 1C, 1D and 2A, 2B, 2C, 2D) require user-provided 9-30 VDC power sources. Terminals 1M and 2M are the commons for Channel 1 and Channel 2 inputs. Maximum current consumption is 12 mA per input point.
- Polarity of the input power sources can be reversed. Consideration must be given, however, to the polarity of the field device. Many field devices are designed for only one polarity and can be damaged if power wiring is reversed.
- Outputs have one polarity only and are powered by user-provided 5-36 VDC power sources. The maximum allowable current per output circuit is 1A.
- User Bus 1 and User Bus 2 are independent 8-wire terminal buses. They can be used for additional power rail connections.

High-Speed Counter

Solid state input wiring device

DC types of field devices are configured to either sink or source current. This affects the wiring of the device to the CTRIO module. Refer to the sinking/sourcing section of the appendix in this catalog for a complete explanation of sinking and sourcing concepts.

NPN Field Device (sink)

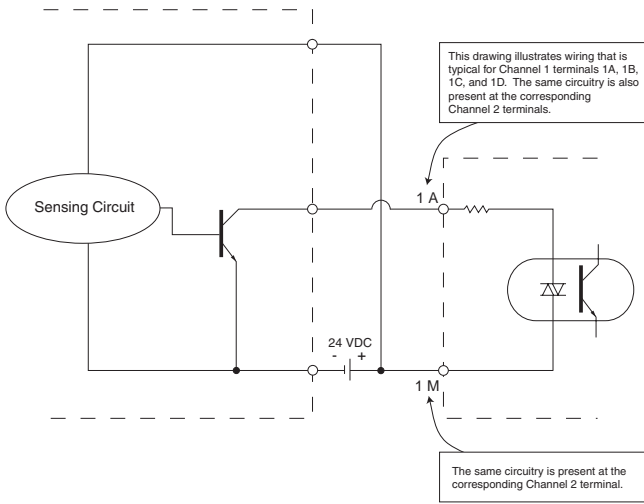

PNP Field Device (source)

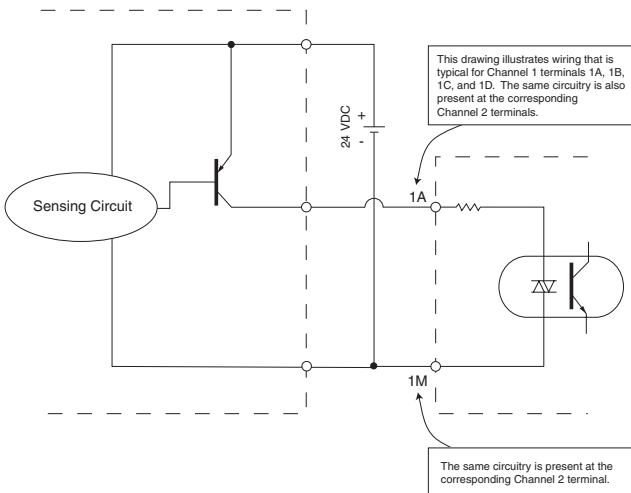

Pulse output schematic

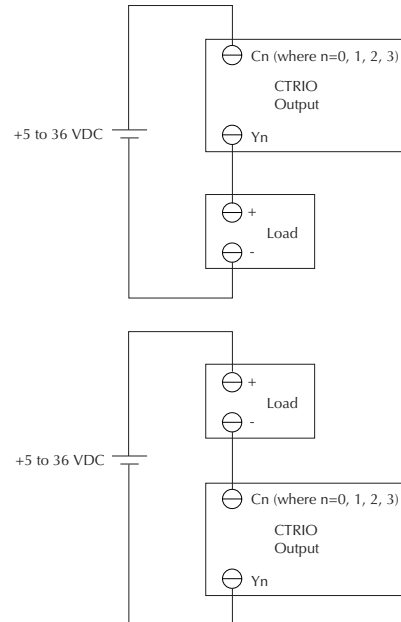

Stepper/servo drive wiring example

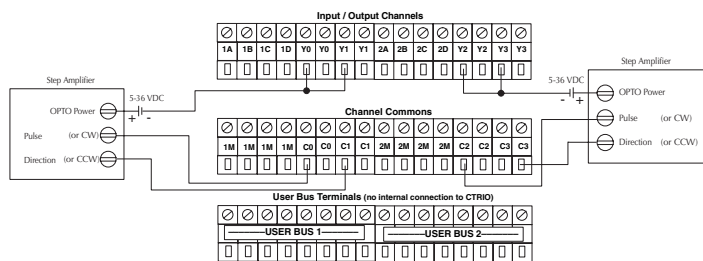

High-Speed Counter

Fill-in-the-blank configuration software

The CTRIO Workbench is the software utility used to configure the CTRIO module and to scale signals to desired engineering units. Workbench also allows you to perform various other functions, such as switching between the CTRIO's Program mode and Run mode, monitoring I/O status and functions, and diagnostic control of module functions. The CTRIO Workbench utility ships with the CTRIO User Manual. You can also download the latest version free at the Host Automation Products, L.L.C. Web site: www.hosteng.com.

CTRIO Workbench main configuration screen

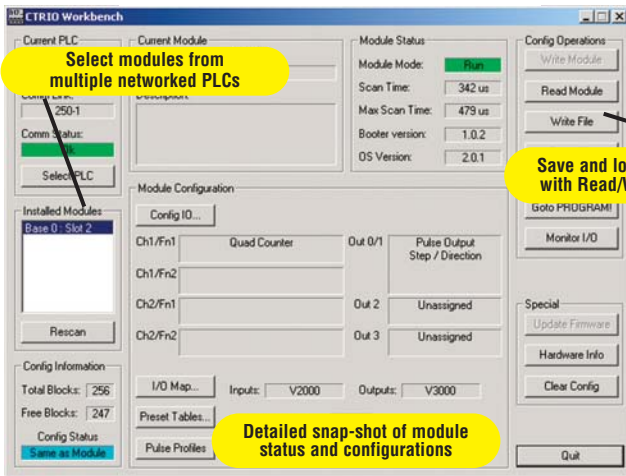

CTRIO Workbench configure I/O setup

The Configure I/O dialog is the location where input and output functions are assigned to the module. The choice of input and output functions determines which options are available. The input function boxes prompt you with selections for supported functions. The Workbench software automatically disallows any unsupported configurations.



T1H-CTRIO

Configure I/O screen

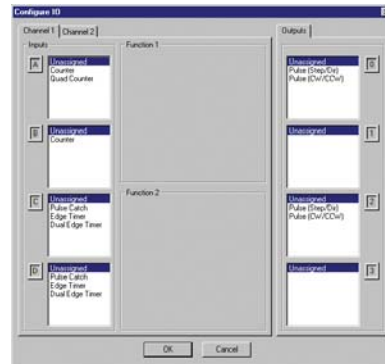

CTRIO Workbench diagnostics and monitoring

The Monitor I/O dialog is accessible from the main Workbench dialog when the module is in Run Mode. This allows for a convenient way to test and debug your configuration prior to installation. The Monitor I/O dialog is divided into three functional areas: Input Functions, Output Functions and System Functions. The data displayed under the Input Functions tab includes all input Dword parameters, status bits and the current status of each configured input and output function. The fields displayed under the Output Functions tab includes all output Dword parameters and configuration information that can be altered during runtime and the bits that indicate successful transfers or errors. The System Functions can be used to read from or write to the CTRIO's internal registers.

Monitor I/O screen

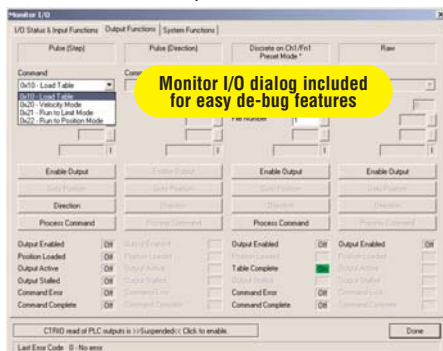

CTRIO Workbench on-board scaling

Scaling raw signals to engineering units is accomplished using the Scaling Wizard. The Scaling Wizard options are different for the Counter functions as compared with the Timer functions. "Position" and "Rate" scaling are available when you select a Counter function. "Interval" scaling is available when you select a Timing function.

Scaling Wizard screen

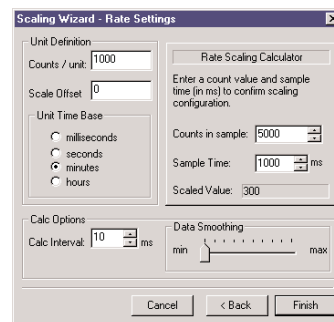

High-Speed Counter

High-speed input operations

The CTRIO module is capable of a wide variety of high speed input and output operations all within one module. With its flexible 2-channel input and separate 2-channel output design, the CTRIO can satisfy both high-speed counting, timing, pulse catch operations, along with high speed discrete output or several profile choices of pulse output operations. Not all combinations of input functions and output functions are possible within the resources of the module, but the following examples are some of the most common applications for the CTRIO. Check out these examples and see how they relate to your high speed application needs.

High-speed timing

The CTRIO can be configured for timing functions based on both count or rate. Using a common configuration of a proximity switch sensing the teeth on a gear, the module is able to calculate the velocity of the gear based on the rate it receives its counts. This value can be scaled within the module to the engineering units required for the application.

High-speed timing application

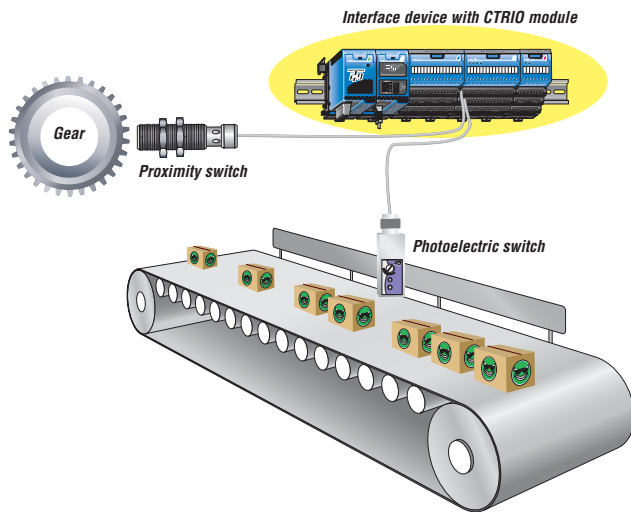

Using Configure I/O screen to configure CTRIO for high-speed timing

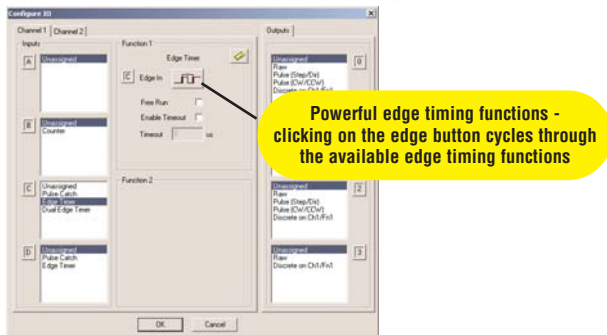

High-speed counting

The CTRIO can be configured for counting functions for the use of an encoder input, (up to two quadrature encoders per module) with available connections for external reset and inhibit signals. In a simple cut to length application as shown, the encoder provides an input position reference for the material to the module. The module's high speed outputs are wired to the cutting device and to the clutch and/or braking device. When the count from the encoder is equal to a pre-programmed setpoint within the module, the high speed outputs are activated to stop and cut the material to a repeatable fixed length. Additionally, the clutch/brake signal can be used for an inhibit signal to not accumulate counts while the material is being cut.

High-speed cut-to-length application

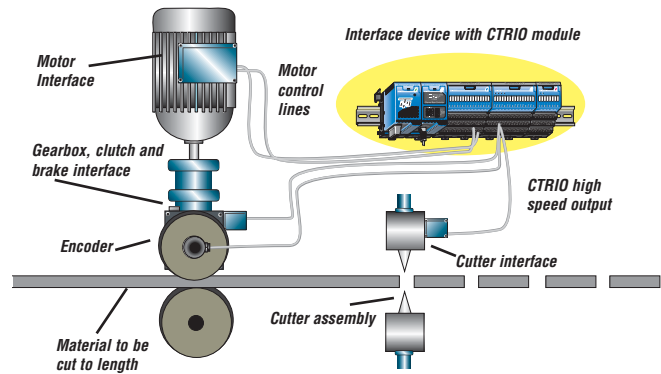

Using Configure I/O screen to configure CTRIO for high-speed counting

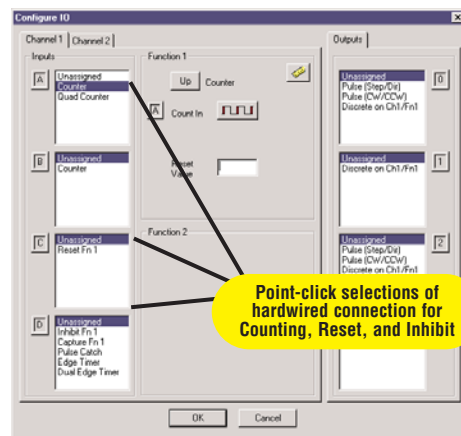

High-Speed Counter

Pulse output operations

Using Edit Pulse Profile screen to select Trapezoid pulse output profile

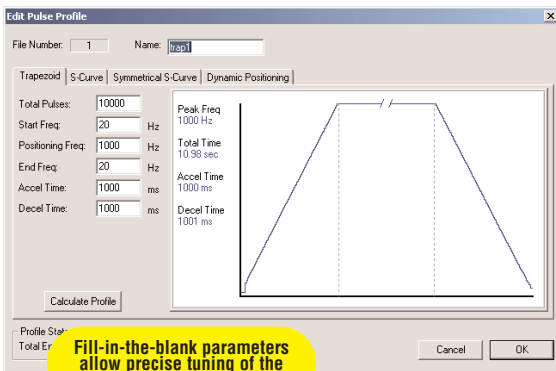

Pulse output for stepper/servo control

The CTRIO module is capable of multiple configurations for pulse output control, most often when connected to a stepper or servo drive system. The module can deliver a pulse output signal up to a maximum of 25 kHz on two channels with support for pulse-and-direction or CW/CCW pulses. The available profile choices include Trapezoid, S-Curve, Symmetrical S-Curve, Dynamic Positioning, and Pulse to Limit. All profiles can be easily configured using the CTRIO Workbench software with fill-in-the-blank parameter fields and a graphic representation of the selected profile. Three additional profiles are available that are completely controlled by the user program (no CTRIO profile is configured). They are Velocity Mode, Run to Limit Mode and Run to Position Mode.

Example application

In a simple rotary indexing application, as shown above, a fixed Trapezoid profile is chosen. The CTRIO for this application is wired to a stepper drive for pulse-and-direction. The requirement for this application is to provide a smooth movement of the rotary table to allow product to be filled into individual containers equal distance apart. The predetermined number of pulses required for each movement is entered into the CTRIO Workbench as "Total Pulses" along with the Starting Frequency, Ending Frequency, and Positioning Frequency (speed after acceleration). The Acceleration and Deceleration parameters are entered in units of time, so no ramp-distance calculations are required. After all parameters are entered, a graphical representation of the configured profile is shown automatically. Once the configuration has been downloaded to the module, all that is needed from the PLC CPU is the Enable Output signal to begin a movement.

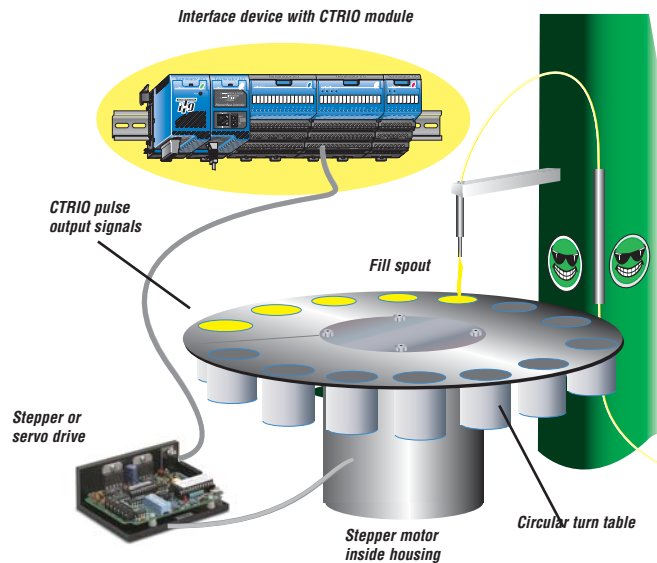

Rotary indexing liquid fill application

Other common pulse output applications:

- S-Curve accel/decel profile for signaling a stepper or servo drive that needs a curved acceleration and deceleration profile, i.e. for diminishing any initial "jerk" upon movement of static products, boxes on conveyors, liquids in containers on an indexer, printing registrations, etc.
- Dynamic Positioning for any run-to-a-specific-position requirement, either by a pre-programmed count of an external high speed discrete input wired to the module. This is popular in winding or webcontrol with any dynamic registration mark or variable speed requirement.
- Home Search routines to seek a home position based on CTRIO discrete input limit(s).

Example of S-Curve acceleration and deceleration pulse output profile

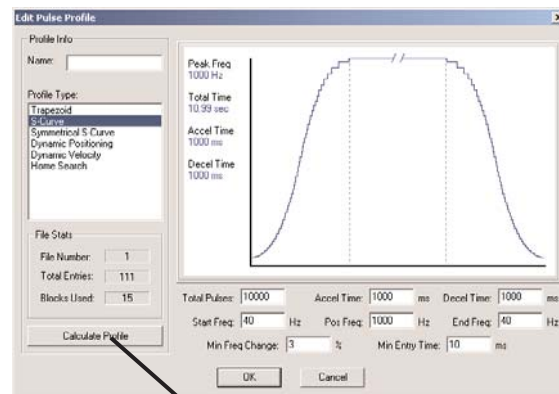

High-Speed Counter

Combining high-speed input and pulse output operations

Using CTRIO Workbench to configure the module for simultaneous high-speed input and high-speed pulse output operation

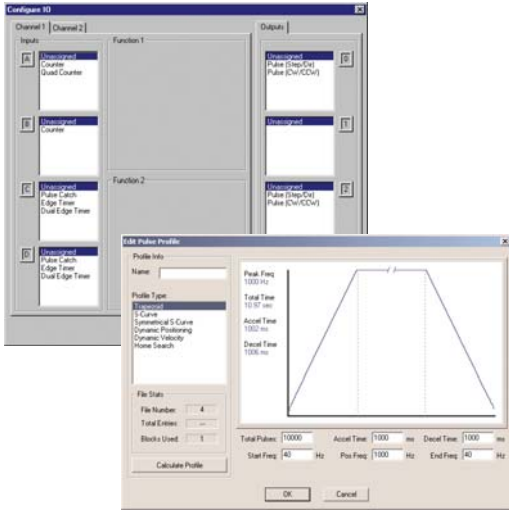

Multihead drill machine application

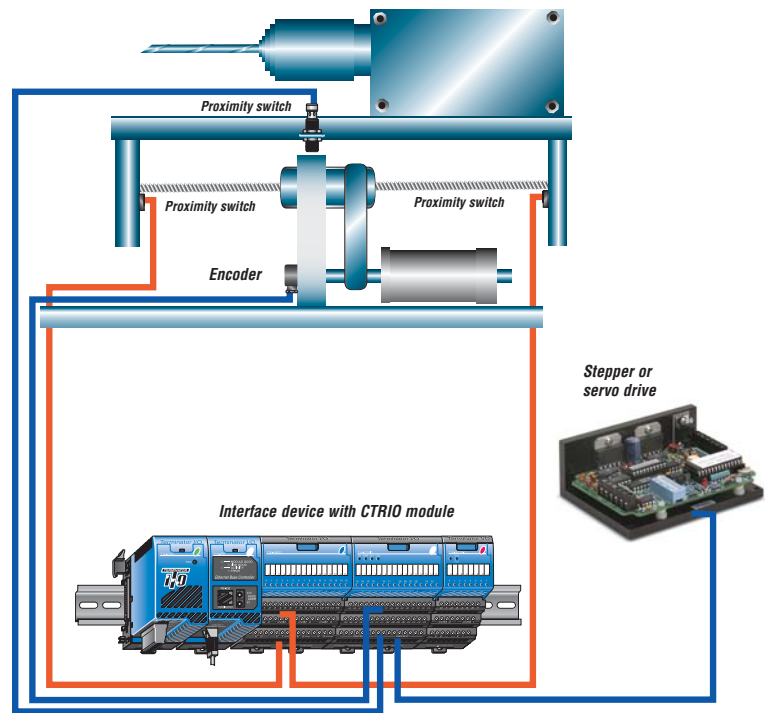

High-Speed inputs and pulse output combinations

The flexible design of the CTRIO module allows for combining high speed inputs and delivering high speed pulse outputs signals simultaneously. There are limitations to this type of configuration in that the module does not internally support closed loop control. Providing closed loop control with the CTRIO involves additional PLC code to coordinate this control, making the application subject to the PLC CPU program scan. Simple position/speed monitoring, via a high speed counting input for non-critical response while providing pulse outputs to a drive, is easily achievable for the CTRIO.

Example application

In the simple drill-head application shown above, the CTRIO pulse outputs are wired to a stepper and/or servo drive. The inputs are wired to an encoder attached to the lead screw on the movable portion of the drill-head assembly. The CTRIO module output pulse train to the drive allows the motor to spin the lead screw making the drill move forward into the passing material. The encoder monitors the speed and position of the drill-head. Prox switches at each end act as limit switches ensuring the drill-head will not over-travel. A home sensor is positioned in the middle of the assembly, allowing the PLC to reset the count.

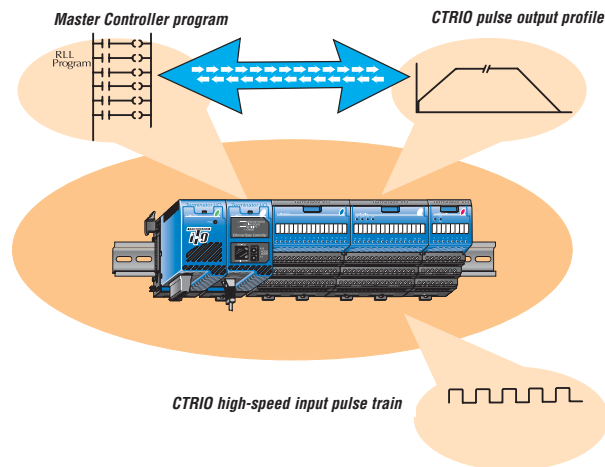

Note: Closed loop control for the CTRIO module requires control program interaction to close the loop. This makes the application subject to the master controller scan.