

PB Series Inductive Proximity Sensors

Nickel-plated Brass - DC



PBT-AN-1H PBT-AN-2H

- Low cost/high performance
- Twelve models available
- IP67 rated
- LED status indicators
- M12 quick-disconnect; order cable separately
- Lifetime warranty

Basic Series Inductive Prox Selection Chart

Part Number	Price	Sensing Range	Housing	Output State	Logic	Connection	Wiring	Dimensions
M12 Models								
PBM-AN-1H	<--->	2 mm (0.079 in)	Shielded	N.O.	NPN	M12 (12 mm) connector	Diagram 1	Figure 1
PBM-AP-1H	<--->				PNP	M12 (12 mm) connector	Diagram 2	
PBM-AN-2H	<--->	4 mm (0.157 in)	Unshielded		NPN	M12 (12 mm) connector	Diagram 1	
PBM-AP-2H	<--->				PNP	M12 (12 mm) connector	Diagram 2	
M18 Models								
PBK-AN-1H	<--->	5 mm (0.197 in)	Shielded	N.O.	NPN	M12 (12 mm) connector	Diagram 1	Figure 2
PBK-AP-1H	<--->				PNP	M12 (12 mm) connector	Diagram 2	
PBK-AN-2H	<--->	8 mm (0.315 in)	Unshielded		NPN	M12 (12 mm) connector	Diagram 1	
PBK-AP-2H	<--->				PNP	M12 (12 mm) connector	Diagram 2	
M30 Models								
PBT-AN-1H	<--->	10 mm (0.394 in)	Shielded	N.O.	NPN	M12 (12 mm) connector	Diagram 1	Figure 3
PBT-AP-1H	<--->				PNP	M12 (12 mm) connector	Diagram 2	
PBT-AN-2H	<--->	15 mm (0.590 in)	Unshielded		NPN	M12 (12 mm) connector	Diagram 1	
PBT-AP-2H	<--->				PNP	M12 (12 mm) connector	Diagram 2	

Wiring diagrams

Diagram 1

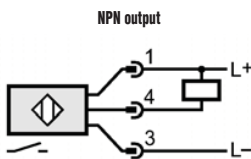
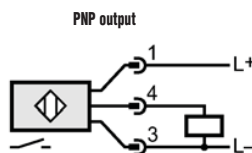

Diagram 2



M12 Connector



Cable Assembly Wiring Colors:

Pin 1 - Brown

Pin 3 - Blue

Pin 4 - Black

PB Series Inductive Proximity Sensors

Specifications	M12 Models		M18 Models		M30 Models	
	Shielded	Unshielded	Shielded	Unshielded	Shielded	Unshielded
Type						
Operating Distance	2 mm (0.079 in)	4 mm (0.157 in)	5 mm (0.197 in)	8 mm (0.315 in)	10 mm (0.394 in)	15 mm (0.590 in)
Material Correction Factors	See Material Influence table #2 later in this section.					
Switch-point Drift	-10 to 10% Sr					
Hysteresis	1 to 20% Sr					
Operating Voltage	15 to 30 VDC					
Current Consumption	<15 mA					
Load Current	100 mA					
Short-circuit Protection	Yes, pulsed					
Reverse Polarity Protection	Yes					
Overload Protection	Yes					
Voltage Drop	<2.5 V					
Output Type	NPN or PNP, N.O. only					
Leakage Current	<0.1 mA					
Switching Frequency	800Hz		400Hz		300Hz	
Temperature Range (Operating)	-25° to 70°C (-13° to 158°F)					
Protection Degree (DIN 40050)	IEC IP67					
Shock Resistance	IEC 60947-5-2 part 7, 4, 2					
Vibration Resistance	IEC 60947-5-2 part 7, 4, 1					
Agency Approvals	cULus file E328811, CE, RoHS					
LED Indicators / Switching Status	Yellow (output energized)					
Housing Material	Housing: brass, nickel-plated; Lock nuts: brass					
Sensing Face Material	Polybutylene Terephthalate (PBT)					
Tightening Torque	7.0 Nm (5.16 lb./ft.)		35.0 Nm (25.8 lb./ft.)		50.0 Nm (36.8 lb./ft.)	
Weight	1.70 g (0.06 oz)		2.83 g (0.10 oz)		8.50 g (0.30 oz)	
Connectors	M12 connector. 2 lock nuts included					

Dimensions

mm [inches]

Figure 1

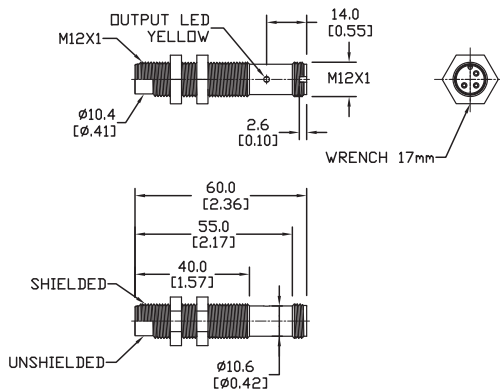

Figure 2

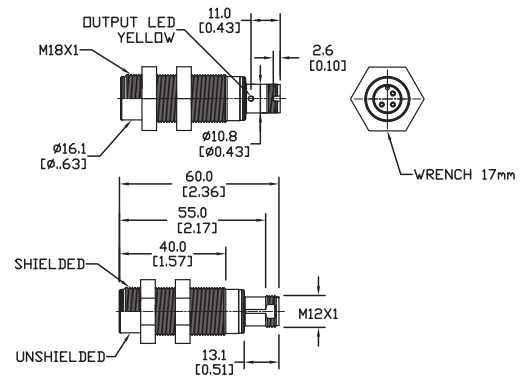
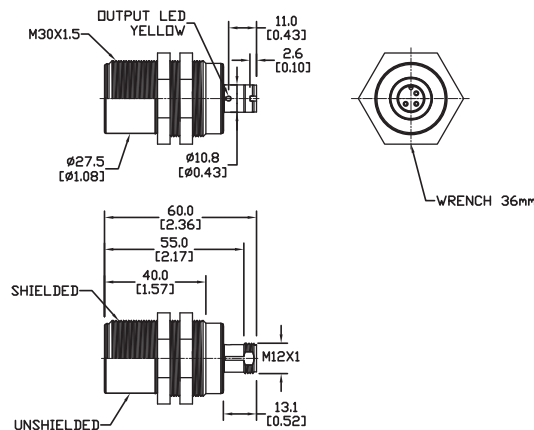

Figure 3



Sensors Accessories: Cables

Cables with quick-disconnect plugs

- Industry standard axial and right-angle M8/M12 screw-lock connectors with open leads. The cables listed can be used with patch cables
- 2m, 5m, 7m and 10m cable lengths
- PVC (polyvinyl chloride) jacket for typical industrial applications
- PUR (polyurethane) jacket for oily and direct sunlight applications
- IP67 rated



CD12M-0B-050-C1 and -A1 shown

M8 Quick-Disconnect Cables (Pico, Nano)							
Part Number	Price	Length	Poles	Connector	LED	Jacket	Dimensions
M8 Quick-Disconnects							
CD08-0A-020-A1	<--->	2m (6.5ft.)	3	Axial	No	PVC	Figure 1
CD08-0A-020-C1	<--->	2m (6.5ft.)	3	Right-angle	No	PVC	Figure 2
CD08-0A-050-A1	<--->	5m (16.4ft.)	3	Axial	No	PVC	Figure 4
CD08-0C-050-A1	<--->	5m (16.4ft.)	3	Axial	No	PUR	Figure 3
CD08-0A-050-C1	<--->	5m (16.4ft.)	3	Right-angle	No	PVC	Figure 5
CD08-0C-050-C1	<--->	5m (16.4ft.)	3	Right-angle	No	PUR	Figure 5
CD08-0A-070-A1	<--->	7m (23ft.)	3	Axial	No	PVC	Figure 1
CD08-0A-070-C1	<--->	7m (23ft.)	3	Right-angle	No	PVC	Figure 2

M12 Quick-Disconnect Cables (Euro, Micro DC-Single Key)							
Part Number	Price	Length	Poles	Connector	LED	Jacket	Dimensions
M12 Quick-Disconnects							
CD12L-0B-020-A0	<--->	2m (6.5ft)	4	Axial	No	PVC	Figure 6
CD12L-0B-020-C0	<--->	2m (6.5ft)	4	Right-angle	No	PVC	Figure 7
CD12M-0B-050-A1*	<--->	5m (16.4ft)	3	Axial	No	PVC	Figure 8
CD12M-0D-050-A1*	<--->	5m (16.4ft)	3	Axial	No	PUR	Figure 9
CD12M-0B-050-C1*	<--->	5m (16.4ft)	3	Right-angle	No	PVC	Figure 10
CD12M-0D-050-C1*	<--->	5m (16.4ft)	3	Right-angle	No	PUR	Figure 11
CD12M-0B-070-A1	<--->	7m (23ft)	4	Axial	No	PVC	Figure 6
CD12M-0B-070-C1	<--->	7m (23ft)	4	Right-angle	No	PVC	Figure 7

* Note: Do not use with: DM, FA, QX, SS, SSF, SU, TU, VM, VK, MV, MS or MSF series sensors. These sensors require 4-pole cables.

Cables with LED and quick-disconnect plugs

- Industry standard M12 right angle female plug with open leads
- These cables can be used with patch cables
- 2m, 5m and 10m cable lengths
- PUR (polyurethane) jacket for oily and direct sunlight applications
- IP67 / IP68 / IP69K, II rated
- LED indication for 10 -36 VDC PNP sensors only

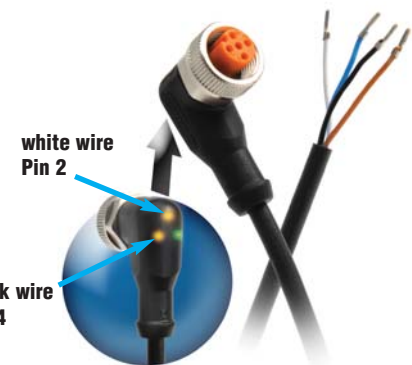

M12 Quick-Disconnect Cables with LED Indicator (Euro, Micro DC-Single Key)							
Part Number	Price	Length	Poles	Connector	LED	Jacket	Dimensions
M12 Quick-Disconnects							
EVC178*	<--->	2m (6.5ft)	4	Right-angle	Yes	PUR	Figure 12
EVC179*	<--->	5m (16.4ft)	4	Right-angle	Yes	PUR	Figure 12
EVC180*	<--->	10m (32.8ft)	4	Right-angle	Yes	PUR	Figure 12

*Note: LED for 10 to 36 VDC PNP only.
Do not use when white wire (Pin 2) is used for selection of a sensor function.

LED Models' Wiring

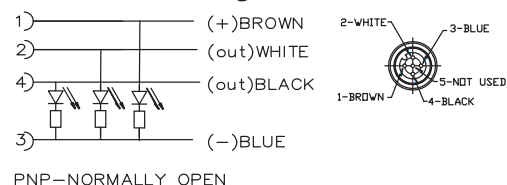

Sensors Accessories: Cables

Cable Specifications					
Specification	M8		M12		M12 with LED
Length	2m (6.5ft) / 7m (23ft)	5m (16.4ft)	2m (6.5ft) / 7m (23ft)	5m (16.4ft)	2m (6.5 ft) / 5m (16.4ft) / 10m (32.8ft)
Nominal Voltage	50VAC/75VDC	60VAC/DC	300VAC	250VAC/DC	10 to 36VDC
Max Current	4A		4A		4A
LED Current Loading	N/A	N/A	N/A	N/A	10V input Brown wire LED: 1.7mA White and/or Black LED: 0.9mA 36V input Brown wire LED: 7.3mA White and/or Black LED: 4.7mA
Protection Degree	IP67	IP65 / IP68 / IP69K	IP67	PVC: IP68 PUR: IP68 / IP69K	IP67 / IP68 / IP69K
Material Nut	brass; nickel plated		brass; nickel plated		brass; nickel plated
Jacket Material	PVC	PVC:CD08-0A-xxx. PUR:CD08-0C-xxx	PVC	PVC:CD12M-0B-xxx. PUR:CD12M-0D-xxx	PUR
Housing Material	PUR		PUR		PUR
Contacts Material	Copper-Tin Alloy (CuSn) -gold plated		Copper-Tin Alloy (CuSn) -gold plated		Gold plated brass
Tightening Torque	0.5 Nm	≤ 0.4 Nm	0.5 Nm	≤ 0.4 Nm	0.6 to 1.5 Nm
Conductors Cross Section (AWG)	0.25mm ² (24 AWG)	0.25mm ² (24 AWG)	0.25mm ² (24 AWG)	0.34mm ² (22 AWG)	4 x 0.34mm ² (4 x 22 AWG)
Ø Outer Cable	5mm	PVC: 4 mm PUR: 4 mm	5mm	PVC: 4.2 mm PUR: 4.3 mm	5mm
Temperature Range	-25° to +80°C (-13° to 176°F)	-25° to 90°C (-13° to 194°F)	-25° to +80°C (-13° to 176°F)	PVC: -30° to 70°C (-22° to 158°F) PUR: -50° to 90°C (-58° to 194°F)	-25° to +90°C (-13° to 194°F)
Environmental	N/A	Halogen free, Silicone free	N/A	Halogen free, Silicone free	Halogen free, Silicone free
Function Display Power LED	N/A	N/A	N/A	N/A	Green
Switching Status LED	N/A	N/A	N/A	N/A	2 x Yellow
Drag Chain (Roller Cable Tray) Suitability	Bending Radius	min. 10 x cable diameter			
	Bending Cycles	N/A	N/A	N/A	>5 million
	Travel Speed	N/A	N/A	N/A	Max. 3.3 m/s for a horizontal travel length of 5 meters and max. acceleration of 5 m/s ²
	Torsional Strain	N/A	N/A	N/A	±180°/m
Agency Approvals	RoHS				UL File E191684, RoHS

UL Reference	
Part Number	Mini-Series Female Cord Connectors Series M12, UL Catalog Number
EVC178	ADOAH043MSS0002H04
EVC179	ADOAH043MSS0005H04
EVC180	ADOAH043MSS0010H04
Note: Shown in UL file under Mini-series Female Cord Connectors using catalog number	

Sensors Accessories: Cables

Dimensions (in/mm)

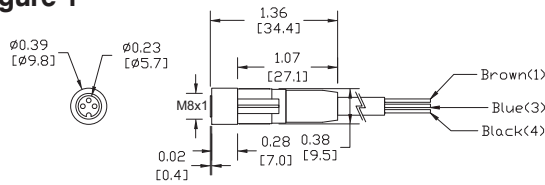
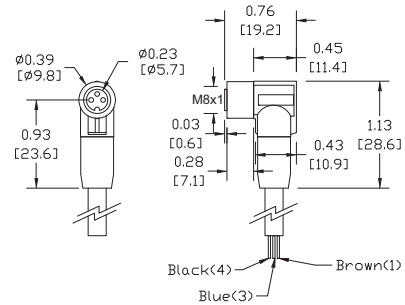
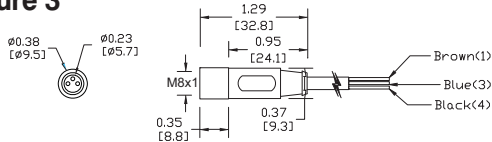
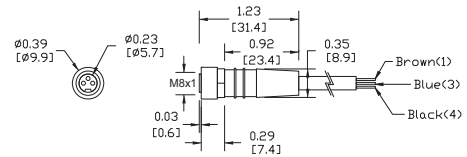
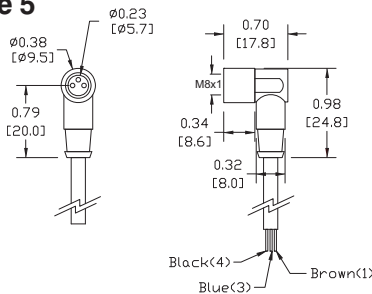
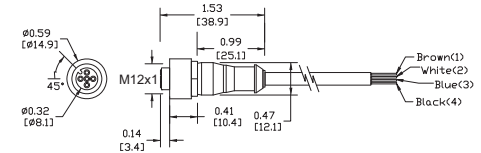
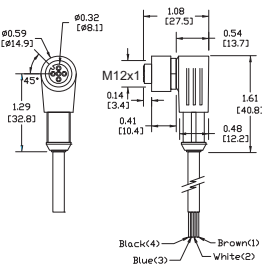
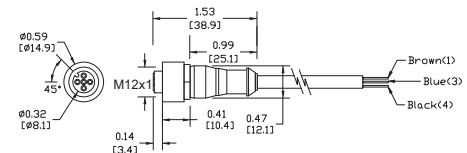
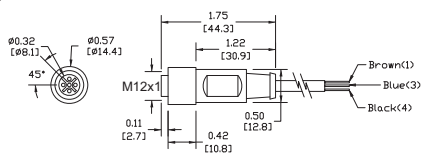
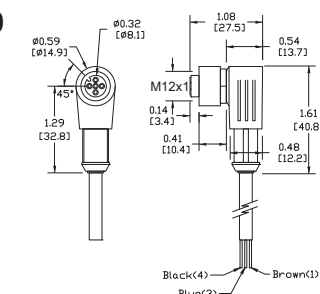
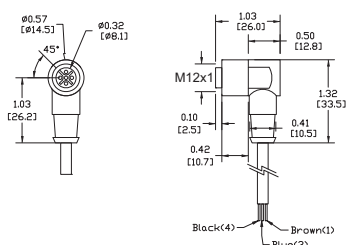
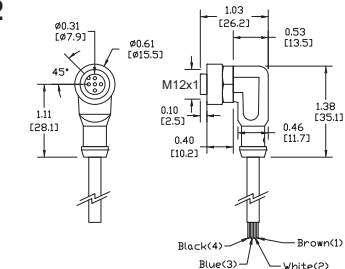
Figure 1

Figure 2

Figure 3

Figure 4

Figure 5

Figure 6

Figure 7

Figure 8

Figure 9

Figure 10

Figure 11

Figure 12

Sensors Accessories: Cables

Patch cables with quick-disconnect plugs on each end

Available patch cables include:

- Industry standard M8 and M12 screw-lock connectors
- One male and one female connector

- Axial and right-angle connector models
- 1m and 3m cable lengths
- PVC (polyvinyl chloride) jacket for typical industrial applications
- IP67 rated



M8 Patch Cables with Quick-Disconnect on Each End (Pico, Nano)

Part Number	Price	Length	Poles	Connectors	Jacket	Dimensions
M8 Quick-Disconnect Patch Cables						
CDP08-0A-010-AA	<--->	1m (3.28ft)	3	2 Axial. One male and one female connector	PVC	Figure 1
CDP08-0A-010-BB	<--->	1m (3.28ft)	3	2 Right-angle. One male and one female connector	PVC	Figure 3
CDP08-0A-030-AA	<--->	3m (9.84ft)	3	2 Axial. One male and one female connector	PVC	Figure 2
CDP08-0A-030-BB	<--->	3m (9.84ft)	3	2 Right-angle. One male and one female connector	PVC	Figure 3

M12 Patch Cables with Quick-Disconnect on Each End (Euro, Micro DC-Single Key)

Part Number	Price	Length	Poles	Connectors	Jacket	Dimensions
M12 Quick-disconnect Patch Cables						
CDP12-0B-010-AA	<--->	1m (3.28ft.)	4	2 Axial. One male and one female connector	PVC	Figure 4
CDP12-0B-010-BB	<--->	1m (3.28ft.)	4	2 Right-angle. One male and one female connector	PVC	Figure 5
CDP12-0B-030-AA	<--->	3m (9.84ft.)	4	2 Axial. One male and one female connector	PVC	Figure 4
CDP12-0B-030-BB	<--->	3m (9.84ft.)	4	2 Right-angle. One male and one female connector	PVC	Figure 5

Patch Cables with LED

Available patch cables with LED include:

- Right-angle M12 female plug with LED indication on one end and axial male plug on the other end
- 0.3m, 0.6m, 1m, 2m, 5m, and 10m cable lengths

- PUR (polyurethane) jacket for oily and direct sunlight applications
- IP67 / IP68 / IP69K, II rated
- LED indication for 10 -36 VDC PNP sensors only

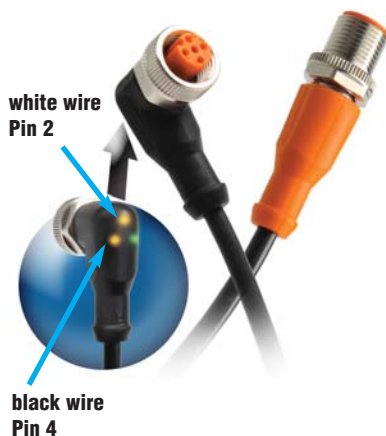

LED Models' Wiring

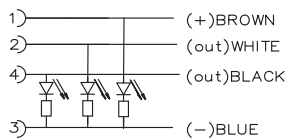

PNP—NORMALLY OPEN

M12 Patch Cables with LED Indicator (Euro, Micro DC-Single Key)

Part Number	Price	Length	Poles	Connectors	LED	Jacket	Dimensions
M12 Patch Cables							
EVC322*	<--->	0.3m (0.98ft)	4	Right-angle female, axial male	Yes	PUR	Figure 6
EVC323*	<--->	0.6m (1.97ft)	4	Right-angle female, axial male	Yes	PUR	Figure 6
EVC324*	<--->	1m (3.28ft)	4	Right-angle female, axial male	Yes	PUR	Figure 6
EVC325*	<--->	2m (6.5ft)	4	Right-angle female, axial male	Yes	PUR	Figure 6
EVC326*	<--->	5m (16.4ft)	4	Right-angle female, axial male	Yes	PUR	Figure 6
EVC327*	<--->	10m (32.8ft)	4	Right-angle female, axial male	Yes	PUR	Figure 6

Note: LED for 10 to 36 VDC PNP only.

Do not use when white wire (Pin 2) is used for selection of a sensor function.

Sensors Accessories: Cables

Cable Specifications		
Specification	M8 / M12	M12 with LED
Length	1m (3.28ft.) / 3m (9.84ft.)	0.3m (0.98ft) / 0.6m (1.97ft) / 1m (3.28ft) 2m (6.5ft) / 5m (16.4ft) / 10m (32.8ft)
Nominal Voltage	50VAC/75VDC	10 to 36VDC
Max Current	4A	4A
	N/A	10V input Brown wire LED: 1.7mA White and/or Black LED: 0.9mA 36V input Brown wire LED: 7.3mA White and/or Black LED: 4.7mA
Protection Degree	IEC IP67	IEC IP67/IP68/IP69K
Material Nut	Brass: nickel plated	Brass: nickel plated
Jacket Material	PVC	PUR
Housing Material	PUR	Connector: Orange PUR, Socket: Black PUR
Contacts Material	Copper-tin(CuSn)=Brass	Brass: gold plated
Conductors Cross Section (AWG)	0.34mm ²	0.34mm ² (22 AWG)
Tightening Torque	0.5 Nm	Plug: 0.6 to 1.5 Nm (take into account the maximum value of the counterpart) Socket: 0.6 to 1.5 Nm
Ø Outer Cable	5mm	5mm
Temperature Range	-25° to +70°C (-13° to 158°F)	-25° to +90°C (-13° to 194°F)
Environmental		Halogen-free, Silicone-free
Function Display LED	N/A	Green
Switching Status LED	N/A	2 x Yellow
Drag Chain (Roller Cable Tray) Suitability	Bending Radius	min. 10 x cable diameter
	Bending Cycles	>5 million
	Travel Speed	N/A Max. 3.3 m/s for a horizontal travel length of 5 m and max. acceleration of 5 m/s ²
	Torsional Strain	N/A ±180°/m
Agency Approvals	RoHS	UL File E191684, RoHS

UL Reference	
Part Number	Cable Assemblies Series M12, UL Catalog Number
EVC322	VDOAH043MSS00.3H04STGH040MSS
EVC323	VDOAH043MSS00.6H04STGH040MSS
EVC324	VDOAH043MSS0001H04STGH040MSS
EVC325	VDOAH043MSS0002H04STGH040MSS
EVC326	VDOAH043MSS0005H04STGH040MSS
EVC327	VDOAH043MSS0010H04STGH040MSS
Note: Shown in UL file under Cable Assemblies using catalog number	

Sensors Accessories: Cables

Dimensions (in/mm)

Figure 1

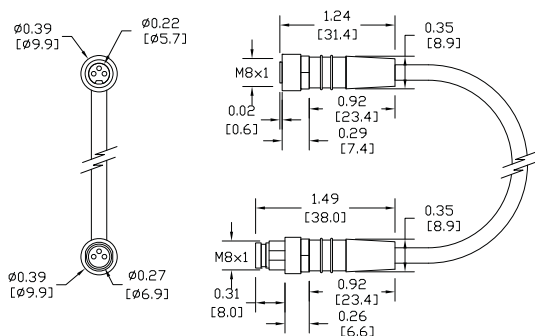

Figure 2

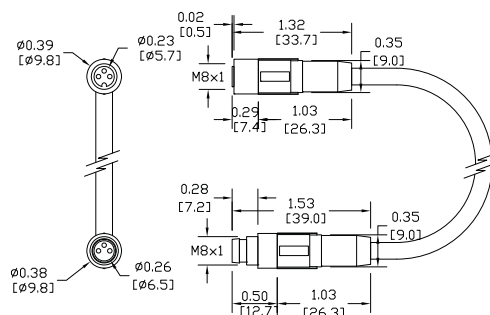

Figure 3

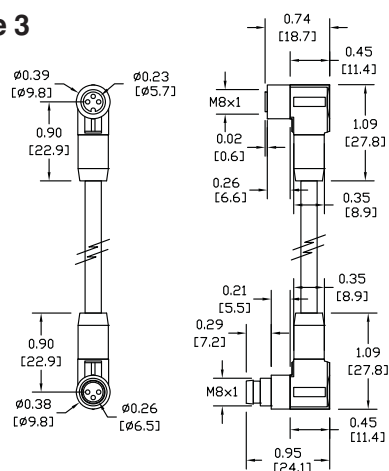

Figure 4

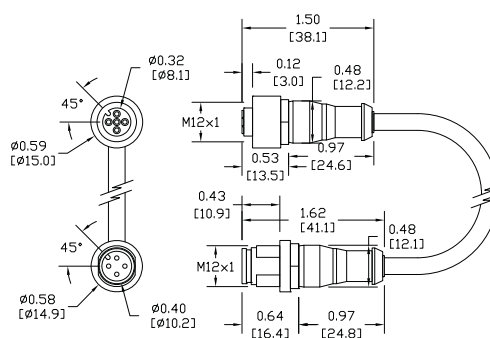

Figure 5

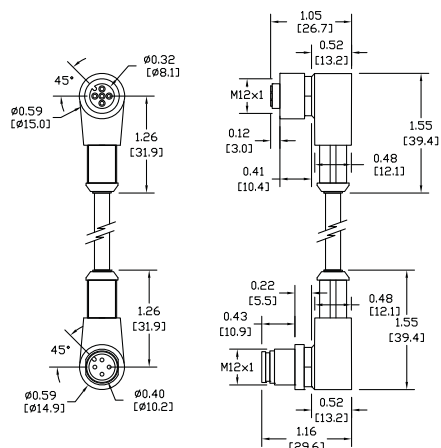
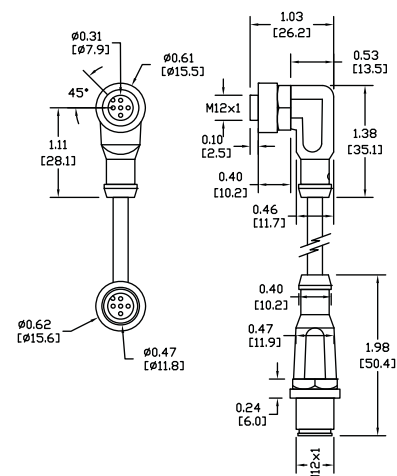

Figure 6



Accessories: Adapter, Mounting Brackets

ST12A axial bracket

For mounting M12 (12 mm) sensors. Has two mounting holes (use 3 mm screws) and allows the rotation of an optical axis for right-beam angle adapter sensors. Hexagonal nuts not included.



ST12C right-angle bracket

Angular mounting bracket for use with M12 (12 mm) sensors. Has two mounting holes (use 3 mm screws) and allows the rotation of an optical axis for axial sensors. Hexagonal nuts not included.



Brackets		
Part Number	Price	Description
ST12A	<--->	Metal axial bracket for 12 mm sensors, 1/pk
ST12A7W	<--->	316L stainless steel axial bracket for 12 mm sensors, 1/pk

Brackets		
Part Number	Price	Description
ST12C	<--->	Metal right angle bracket for 12 mm sensors, 1/pk
ST12C7W	<--->	316L stainless steel right angle bracket for 12 mm sensors, 1/pk

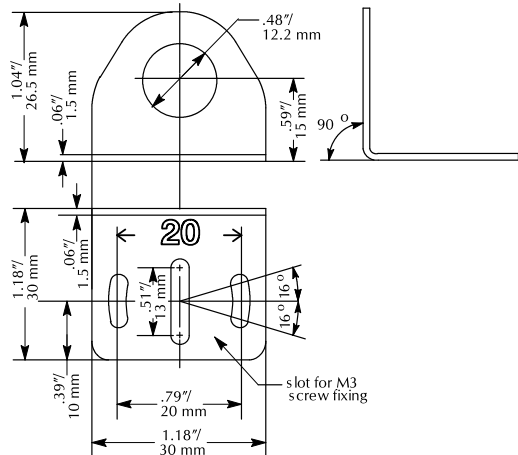
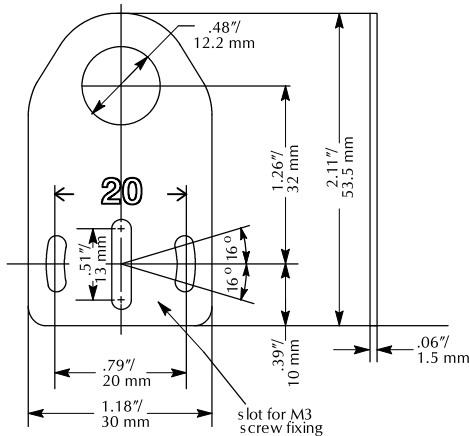

ST18A axial bracket

Mounting bracket for M18 (18 mm) sensors. Has two mounting holes (use 4 mm screws) and allows the rotation of an optical axis for right-beam-angle-adaptor sensors. Hexagonal nuts not included.



ST18C right-angle bracket

Angular mounting bracket for M18 (18 mm) sensors. Has two mounting holes (use 4 mm screws) and allows the rotation of an optical axis for axial sensors. Hexagonal nuts not included.



Brackets		
Part Number	Price	Description
ST18A	<--->	Metal axial bracket for 18 mm sensors, 1/pk
ST18A7W	<--->	316L stainless steel axial bracket for 18 mm sensors, 1/pk

Brackets		
Part Number	Price	Description
ST18C	<--->	Metal right angle bracket for 18 mm sensors, 1/pk
ST18C7W	<--->	316L stainless steel right angle bracket for 18 mm sensors, 1/pk

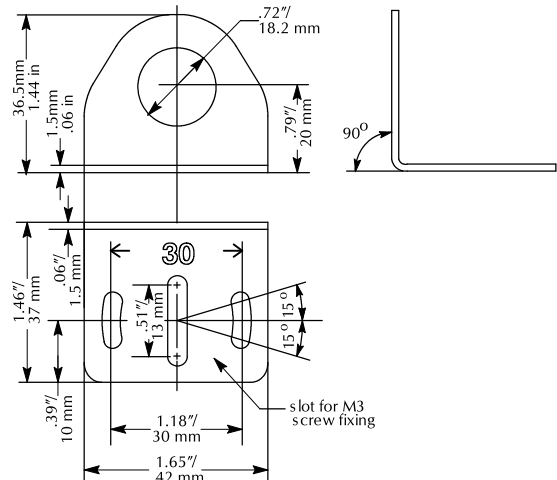
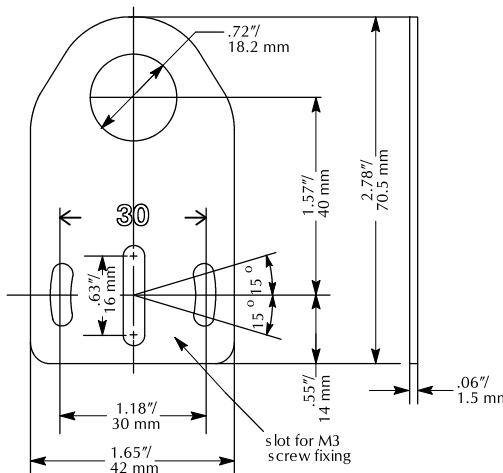

We sell good proximity sensors at great prices – and we back them up!

AutomationDirect Lifetime Warranty

Registration required

For inductive proximity sensors sold to the Original User for the lifetime of the original application.

The following terms apply to the LIFETIME WARRANTY in addition to the General Terms:

1. This warranty is available only to AUTOMATIONDIRECT's authorized Value Added Resellers and to the Original User. In the event the ownership of the product is transferred to a person, firm, or corporation other than the Original User, this WARRANTY shall terminate.
2. This WARRANTY is applicable only to the original installation of the product. In the event the machinery, equipment, or production line to which the product is connected, or on which it is installed, is substituted, changed, moved or replaced, the WARRANTY shall terminate.
3. This WARRANTY shall be valid only if the product was purchased by the Original User from AUTOMATIONDIRECT, or from an authorized AUTOMATIONDIRECT Value Added Reseller, or was an integral part of a piece of machinery and equipment obtained by the Original User from an original equipment manufacturer, where the part was purchased by the original equipment manufacturer directly from AUTOMATIONDIRECT or from an authorized AUTOMATIONDIRECT Value Added Reseller.

Purchaser's remedies

This remedy shall apply to all WARRANTIES. If an AUTOMATIONDIRECT Value Added Reseller desires to make a WARRANTY claim, the Value Added Reseller shall, if requested by AUTOMATIONDIRECT, ship the product to AUTOMATIONDIRECT's facility in Cumming, GA postage or freight prepaid. If the Original User desires to make a WARRANTY Claim, they shall notify the authorized Value Added Reseller from whom it was purchased or, if purchased directly from AUTOMATIONDIRECT, shall notify AUTOMATIONDIRECT and, if requested by AUTOMATIONDIRECT, ship the Product to AUTOMATIONDIRECT's facility in Cumming, GA postage or freight prepaid. AUTOMATIONDIRECT shall, at its option, take any of the following two courses of action for any products which AUTOMATIONDIRECT determines are defective in materials or workmanship.

1. Repair or replace the product and ship the product to the Original User or to the authorized AUTOMATIONDIRECT Value Added Reseller, postage or freight prepaid; or
2. Repay to the Original User that price paid by the Original User; provided that if the claim is made under the lifetime warranty, and such product is not then being supplied by AUTOMATIONDIRECT, then the amount to be repaid by AUTOMATIONDIRECT to the Original User shall be reduced according to the following schedule:

Number of Years Since Date of Purchase by Original User	Percent of Original Purchase Price To Be Paid by AutomationDirect
10	50 percent
15	25 percent
20	10 percent
More than 20	5 percent

REMEDIES OF PURCHASER'S AND VALUE ADDED RESELLERS SHALL BE LIMITED EXCLUSIVELY TO THE RIGHT OF REPLACEMENT, REPAIR OR REPAYMENT AS PROVIDED ABOVE AND DOES NOT INCLUDE ANY LABOR COST OR REPLACEMENT AT ORIGINAL USER'S SITE. AUTOMATIONDIRECT.COM SHALL NOT BE LIABLE FOR ANY CONSEQUENTIAL DAMAGES RESULTING FROM ANY BREACH OF ANY WARRANTY, EXPRESSED OR IMPLIED, APPLICABLE TO THE PRODUCT, INCLUDING WITHOUT LIMITATION, ANY DAMAGES RESULTING FROM PROPERTY DAMAGE, PERSONAL INJURY OR BUSINESS INTERRUPTION, EVEN IF NOTIFIED OF THE POSSIBILITY OF SUCH DAMAGES.

Inductive proximity sensors warranty form may be obtained online at:

<http://www.automationdirect.com/static/specs/proxwarranty.pdf>